

Product LA31H1575-A41

Specification

Frequency Range	1555MHz~1595MHz
V.S.W.R	≤2.0
Impedance	50Ω
Gain	1.41dBi
Azimuth	Omni-directional
Polarization	Linear
Impedance	50 Ω
Azimuth Beam width	Omni-directional

Dimension (mm)

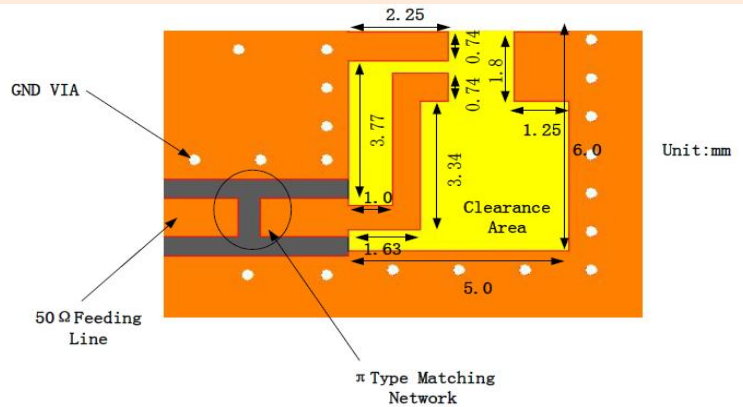
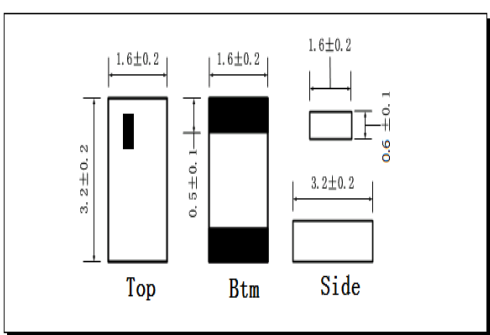

Performance

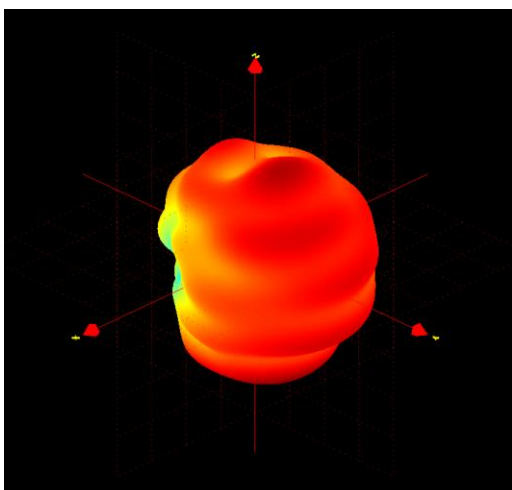

Test Graph

